

VENTILATORE CENTRIFUGO
CENTRIFUGAL FAN

VASCA ACQUA
WATER TANK

QUADRO ELETTRICO
ELECTRIC BOARD

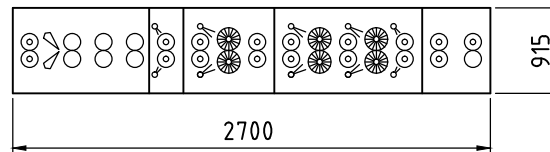
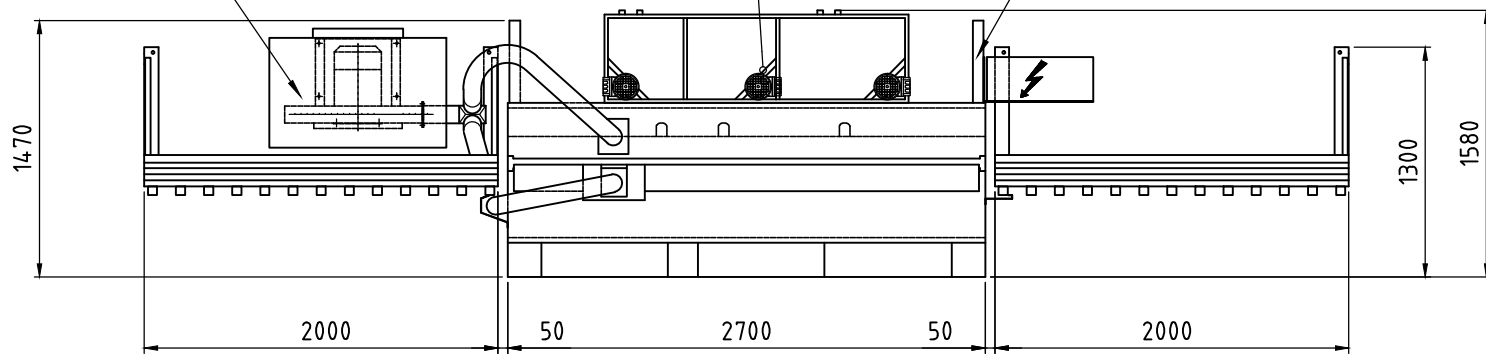

OT 1600/500/6S